

E013SPL830DAASS | KEPLERO 280 Adjustable Professional inground recessed adjustable LED projector

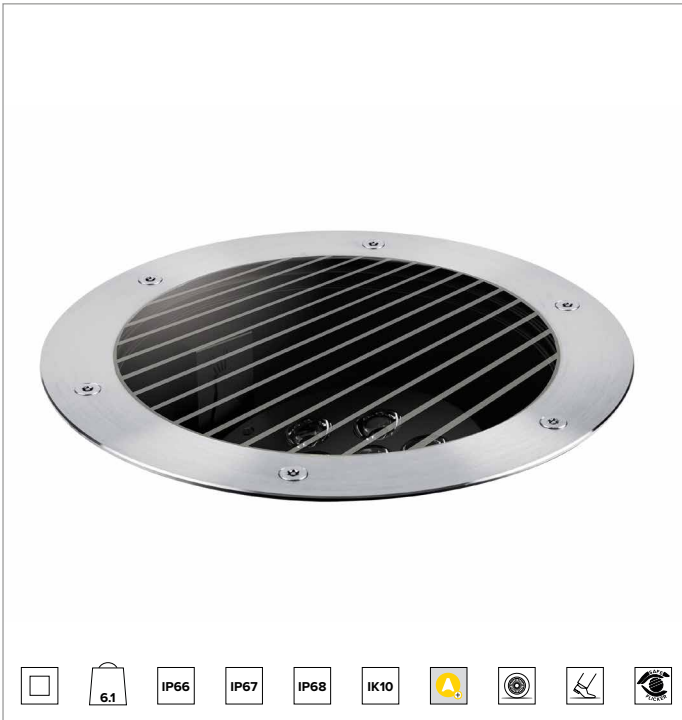

	3000K	H(m)	D(m)	Emax(lx)
	Ra80		11°	
Fixture Power	39W	1	0.19	68228
Source Flux	4532lm	2	0.37	17057
Fixture Flux	3518lm	3	0.56	7581
Efficacy	90lm/W	4	0.74	4264
TS1943	Imax=15055cd/klm	Imax	68228cd	5
			0.93	2729

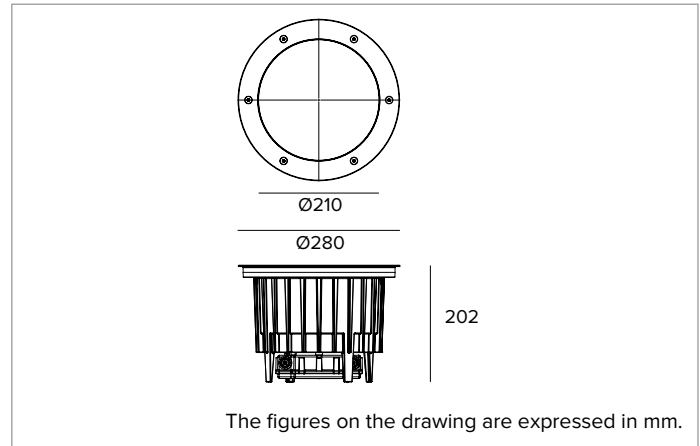

SOURCE

Ra80 high efficiency High Power LED. 3500K colour temperature available on request.

Energy efficiency class: E

Nominal power: 34W

Nominal flux: 4532lm

Colour rendering index: 80

Rf: 83.1

Rg: 98.2

CCT nominal: 3000K

Lifetime (L80/B10): >50000h tq +25°C

ILLUMINOTECHNICAL CHARACTERISTICS

Optical system with an optical grade PMMA lens and a holographic diffusing filter. Tilting optic adjustable up to 30° on the vertical plane and 210° on the horizontal plane with a friction aim locking system. Designed for the installation of multiple optical accessories to be ordered separately.

Optic: LENS

Beam angles: SP

Optical efficiency: 78%

Fixture flux: 3518lm

Luminous efficacy: 90lm/W

Photobiological safety: Compliant with RG1 low risk group

MECHANICAL CHARACTERISTICS

Die-cast aluminium body with 3 layers of protection: anodised, cataphoresis and black paint. Brushed stainless steel (AISI 316) ultra flat decorative ring with bevelled edge (natural finish). Version with anti-slip protective glass for public pedestrian areas. Anti theft stainless steel A4 Torx screws.

Colour and finish: Brushed stainless steel

Weight: 6.1Kg

Version: STANDARD

Degree of protection: IP66,IP67,IP68

Mechanical Resistance: IK10

ELECTRICAL CHARACTERISTICS

Integrated IP68 DALI power supply equipped with IP68 waterproof connectors set for connection to the mains with a H07RN8-F (max2x2.5mm²) cable. Fixture with a pass-through line. Casambi control system available using a dedicated accessory (only for DALI version products).

Fixture Power: 39W

Power supply: 220-240Vac 50/60Hz

Insulation Class: CLASS 2

Type of driver / Control: DALI

Driver included: YES

Class F: YES

SAFE FLICKER: PstLM=<1 and SVM=<0.4 (IEC TR 61547-1 and IEC TR 63158), to ensure a more comfortable and safe light

Ambient temperature: -25°C / +35°C

INSTALLATION

Nylon installation sleeve to be ordered separately as an accessory. The sleeve is pre-set for both flush or straight edge installation. 20kN resistance to static load.

NOTES

All light fixtures must be completed with an installation sleeve. IP68: the projector is not suitable for permanent underwater installation but can withstand temporary accidental immersion to a depth of 2 metres (max.24h). All versions of the KEPLERO family meet all the requirements of EN 60598-2-13 standard regarding drive-over and walk-over performances. Low temperatures on the glass make them suitable even for installation in "special areas", such as spaces for children. Uses the "Waterblock Plus" technical solution that involves resin coating the connection cables and completely resin coating the integrated driver limiting the risk of humidity reaching the fixture. 110-277Vac version available on request. Commissioning of the control system via free APP; the intervention of a specialist technician can be quoted on request.

WARNING

Luminaire designed for disposal/recycling at end-of-life. Replaceable (LED only) light source by a professional. Replaceable control gear by a professional.

Due to the technological evolution of the electronic components, the data provided may be updated, and as such, confirmation must be requested during the order process.

Luminous flux and power supply have +/-10% tolerances with respect to the indicated value. tq +25°C (CIE 121).

We reserve the right to make technical changes.

Targetti Sankey S.r.l.
Via Pratese, 164
50145 Firenze - Italy
Tel: +39 055 37911
targetti.com
targetti@targetti.com

CCIAA Firenze
Share Capital:
€ 500.000,00
VAT N. (IT):
01537660480
R.E.A: FI-275656

TARGETTI

E013SPL830DAASS | KEPLERO 280 Adjustable Professional inground recessed adjustable LED projector

Related codes

Sleeve



Code

1E2394

Grey nylon installation sleeve.
The sleeve is pre-set for both flush or straight edge installation.
Complete with dedicated cover cap for installations in concrete.
Flush ring Ø 286 H.225.
Straight edge ring Ø 271 H. 223.

Accessories

Grid

Code

A062

Anti-glare louver.
Black painted metal honeycomb structure.
The louver is complete with a filter holder ring.

Filter

Code

A063

Flat striped glass blade light refractive filter.
This makes the beam take on an oval shape and when combined with spotlights, the light blade appears more prominent.
The accessory is complete with a filter holder ring.

Tool



Code

1E2496

Metal handle for fixture removal



Code

1E2495

Features TORX HEAD, TX 30.



Code

1E0388

Sucker tool to raise the glass.

Connector



Code

1E2769

Linear connection box IP66/IP68.
5 poles max. wire section 1.5mm².
Cable diameter range from 7 to 12mm.

*Due to the technological evolution of the electronic components, the data provided may be updated, and as such, confirmation must be requested during the order process.
Luminous flux and power supply have +/-10% tolerances with respect to the indicated value. tq +25°C (CIE 121).*

We reserve the right to make technical changes.

Targetti Sankey S.r.l.
Via Pratese, 164
50145 Firenze - Italy
Tel: +39 055 37911
targetti.com
targetti@targetti.com

CCIAA Firenze
Share Capital:
€ 500.000,00
VAT N. (IT):
01537660480
R.E.A: FI-275656

TARGETTI

E013SPL830DAASS | KEPLERO 280 Adjustable Professional inground recessed adjustable LED projector

Control systems



Code

1E3048

IP67 wireless control unit with DALI interface.

It generates a local DALI2 bus, enabling a direct connection to a DALI interface LED driver.

The module can only be used in a closed system and cannot be connected to an existing DALI network.

The module is wireless controlled using a Casambi app for smartphones and tablets using Bluetooth 5.0 technology.

The devices automatically create an adaptive, robust, and reliable wireless mesh network, allowing for the easy and efficient management of a high number of fixtures.

The control unit is preset to the DALI 1CH profile, meaning the device can control a single DALI driver with broadcast commands.

In addition to the DALI broadcast, other operating modes are available, such as:

- Button (normally open)
- Control unit 0/1-10V
- Control unit DALI Tunable White DT8
- Presence sensor



Code

1E4369

IP67 Extender for wireless control of LED driver with dimming DALI interface based on Casambi technology.

It has a DALI2 output with the capacity to control up to 40 lighting fixtures.

With the addition of a further external BUS DALI power supply it is possible to control up to 64 fixtures.

IP67 Extender is preset to the DALI broadcast profile, meaning all the luminaires connected to it are dimmable at the same level.

In addition to the DALI broadcast other operating modes are available, such as:

- EXTENDER DALI 8CH
- EXTENDER DALI Tunable White
- EXTENDER DALI 4CH
- EXTENDER DALI DT8 Tunable White

Surge protector



Code

A013D

Surge protector compatible with CLASS II lighting fixtures.

DALI, DMX, 0-10V datalines compliance.

Operating voltage 230-277Vac.

SPD type 2+3.

Max surge protection 10kV.

CLASS II

IP65

Due to the technological evolution of the electronic components, the data provided may be updated, and as such, confirmation must be requested during the order process.

Luminous flux and power supply have +/-10% tolerances with respect to the indicated value. tq +25°C (CIE 121).

We reserve the right to make technical changes.

Targetti Sankey S.r.l.
Via Pratese, 164
50145 Firenze - Italy
Tel: +39 055 37911
targetti.com
targetti@targetti.com

CCIAA Firenze
Share Capital:
€ 500.000,00
VAT N. (IT):
01537660480
R.E.A: FI-275656

TARGETTI